



# INVINCI TUBE

10W / 20W INVINCI  
RECESSED MOUNTED  
LUMINAIRE



FIXTURE  
COLOUR OPTIONS

-  Matt White
-  Matt Black

## APPLICATION

- Hotel and galleries
- Offices
- Retail, fashion stores and showroom
- Residential

## TECHNOLOGY BENEFITS

- Superior light rendering quality offering balanced white with embedded green and red tone
- Excellent cost savings and quicker ROI
- Quick installation, no costly modification required
- Low maintenance
- Comfort, safety and no glass

## FEATURES



- Pulled out and pulled in structure, aesthetic appearance
- Supplied with non-dimmable or phase/0-10V/DALI dimmable LED driver
- 10W: 64.27 lm/W & 20W: 74.75 lm/W
- Colour rendering index:  $\geq 90$
- Colour temperature options: 2700K, 3000K, 4000K
- Beam pattern options: 15°, 24°, 38°
- 3 steps MacAdam ellipse binning
- Uniform and comfort light
- Aluminium & Plastic Material
- IP20

The information above is at nominal values accuracy of  $\pm 7\%$ .

## AVAILABLE OPTIONS

### DRIVER



### TEMPERATURE



### BEAM ANGLE

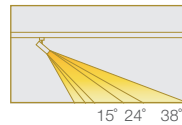

### ACCESSORIES

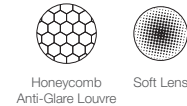

## DIMENSIONS (MM)

\*Displayed height measurements are for highest point of tilting.

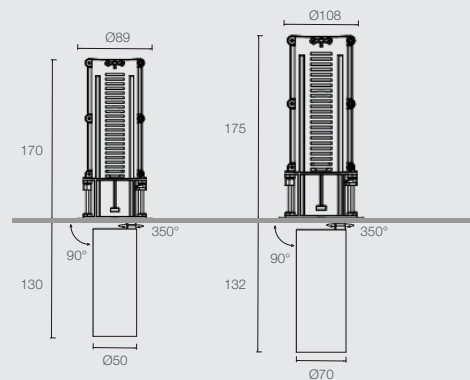

### TUBE 10W

#### POLAR DIAGRAM

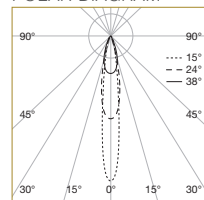

### TUBE 20W

#### POLAR DIAGRAM

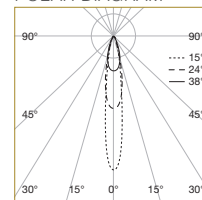

### SYSTEM SPECIFICATIONS

LED Lamp Power	LED System Power	Colour	Beam Angle	CRI 90		Driver Options
				Intensity (cd)	Luminous Flux	
9W	10W	WARM : 2700K WARM : 3000K NATURAL : 4000K	15°	8119	763.5	ND, PH, AN, DA
			24°	4364	778.6	
			38°	1801	740	
17.8W	20W		15°	14480	1570	
			24°	7280	1550.8	
			38°	3733	1499.8	

Data are based on 3000K. Nominal data of 2700K and 4000K are shared with 3000K. Higher CCT of 4000K will have a nominal data value of 5% higher than published.

the table information is at nominal values accuracy of +/-7% nominal CRI -95, equal to Ra >90-97, R9 > 50

### DETAILS SPECIFICATION

Family Type	Tube Series
Mains voltage	220-240V
Colour options	Matt Black, Matt White
Installation Compatibility	Invinci Tube
Lifetime	50,000 HOURS (80% lumen maintenance at Ta = 25°C)
Dimming	Phase, 1-10V, DALI
Mains connection	Screw terminal connection
Materials	Aluminium, plastic
Fire safety	VW-1
Flammability mark	F
IP code	IP20
Safety class	Class 2
Standards	IEC 60598-1, IEC 61347-2-13
Regulatory markings	CE, CCC
Dimensions	Ø50 x 130mm / Ø70 x 132mm

FIXTURE						DRIVER
LED Power	Colour	Accessories	Beam Angle	Colour Temp	CRI	Dimming
<b>INVINCI-10</b> 10W	—	—	—	—	—	—
<b>INVINCI-20</b> 20W	<b>WH</b> Matt White	None	<b>15</b> 15°	<b>27</b> 2700K	<b>90</b> CRI 90	<b>ND</b> Non-Dim
	<b>MB</b> Matt Black	<b>AGL</b> Anti-Glare Louvre	<b>24</b> 24°	<b>30</b> 3000K		<b>PH</b> Phase
		<b>SL</b> Soft Lens	<b>38</b> 38°	<b>40</b> 4000K		<b>AN</b> 0-10V
						<b>DA</b> DALI

example: INVINCI-10.WH.15.30.90.DA